

Colorado DOT Distress Manual For HMA and PCC Pavements



...Pavement Preservation



**The National Center for Pavement Preservation
Michigan State University
2857 Jolly Road
Okemos, MI 48864
(517) 432-8220**

TABLE OF CONTENTS

I	DISTRESSES IN HOT MIX ASPHALT (HMA) PAVEMENTS	2
1.	Fatigue Cracking – [HMA Pavement Distress]	2
2.	Block Cracking – [HMA Pavement Distress]	5
3.	Edge Cracking – [HMA Pavement Distress]	8
4.	Longitudinal Cracking – [HMA Pavement Distress]	10
5.	Reflective Cracking – [HMA Pavement Distress]	13
6.	Transverse Cracking – [HMA Pavement Distress]	15
7.	Rutting – [HMA Pavement Distress]	18
8.	Shoving – [HMA Pavement Distress]	21
9.	Bleeding – [HMA Pavement Distress]	23
10.	Polished Aggregate – [HMA Pavement Distress]	25
11.	Raveling – [HMA Pavement Distress]	26
	II DISTRESSES IN PORTLAND CEMENT CONCRETE (PCC) PAVEMENTS	29
1.	Corner Breaks – [Rigid Pavement Distress]	29
2.	Durability Cracking (“D” Cracking) – [Rigid Pavement Distress]	32
3.	Longitudinal Cracking – [Rigid Pavement Distress]	35
4.	Transverse Cracking – [Rigid Pavement Distress]	38
5.	Joint Seal Damage (Longitudinal and Transverse) – [Rigid Pavement Distress]	41
6.	Longitudinal Joint Spalling – [Rigid Pavement Distress]	42
7.	Transverse Joint Spalling – [Rigid Pavement Distress]	45
8.	Map Cracking and Scaling – [Rigid Pavement Distress]	48
9.	Polished Aggregate – [Rigid Pavement Distress]	50

I Distresses in Hot Mix Asphalt (HMA) Pavements

1. Fatigue Cracking – [HMA Pavement Distress]

Description:

Fatigue cracking (Figure 1) occurs in areas subjected to repeated traffic loadings. In the early stages, this distress can be a series of interconnected cracks, later developing into many-sided, sharp-angled pieces, usually less than 2 feet on the longest side, with the characteristic alligator pattern or chicken wire appearance. (Figure 2) Cracking begins at the bottom of the HMA layer or the stabilized base and propagates to the surface. This alligator cracking is a major structural distress and normally occurs with rutting.

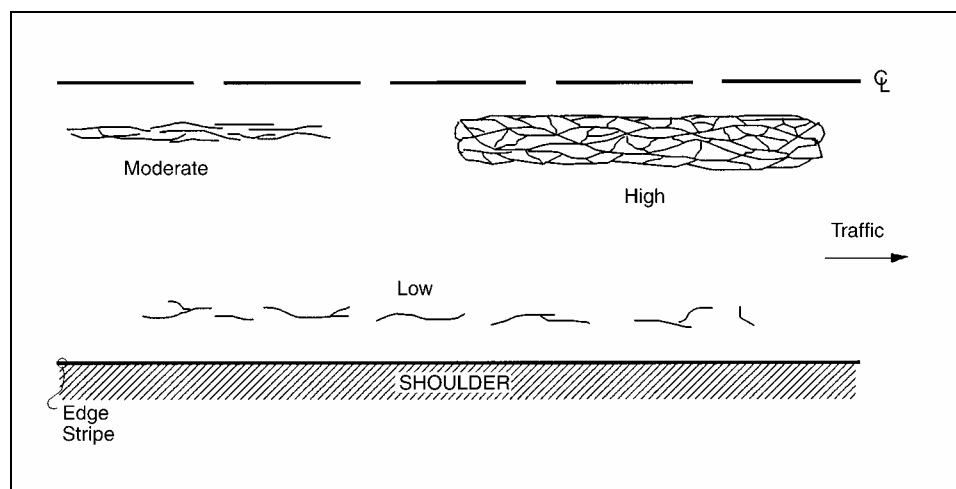

Figure 1 – Fatigue Cracking



Figure 2 – Chicken Wire/Alligator Pattern Cracking

Colorado DOT
Distress Identification Manual
October 2004

Fatigue Cracking (Continued)

Severity Levels:

Low: An area with fine, longitudinal, parallel, hairline cracking with few connecting cracks. The cracks are not spalled or sealed and pumping is not evident. (Figure 3)



Figure 3 - Low Severity Fatigue Cracking

Moderate: An area of interconnected cracks forming a complete pattern or network. The cracks may be lightly spalled or sealed and pumping is not evident. (Figure 4)



Figure 4 - Moderate Severity Fatigue Cracking

High: An area of moderately or severely spalled interconnected cracks forming a complete pattern. The pieces may move under traffic, the cracks may be sealed, and pumping may be evident. (Figure 5)

Fatigue Cracking (Continued)



Figure 5 - High Severity Fatigue Cracking with Spalled Interconnected Cracks

Treatments:

Low: This is a candidate for either - crack filling, sand seal, or chip seal treatment.

Moderate: Treatments for a moderate severity level could be either - Nova Chip, HMA Overlay or a Surface Milling with a HMA Overlay.

High: The high severity level condition is beyond a preservation treatment. Do nothing under the Pavement Preservation Program; handle under either as a rehab or reconstruction project.

Note: Surface cracks having heavy vegetation growth must be treated with herbicide 7 to 21 days prior to pavement work. A glyphosate herbicide, such as Roundup®, is recommended with 41% minimum active ingredient. After spraying vegetation, wait 5 – 7 days before cleaning the cracks. Debris should be thoroughly removed from the cracks, but never to a depth exceeding 4 inches.

2. Block Cracking – [HMA Pavement Distress]

Description:

Block cracking is a pattern of cracks dividing the pavement surface into approximately rectangular pieces. (Figure 6) The rectangular blocks range in size from 1 square foot to 100 square feet. This distress is caused primarily by shrinkage of the asphalt and daily temperature cycling and is not load related. Block cracking usually occurs over a large portion of the pavement surface, but may occur only in non-traffic areas. The smaller the blocks, the more advanced the hardening of the asphalt. This distress may also occur with fatigue cracking in the wheel paths. (Figure 7)

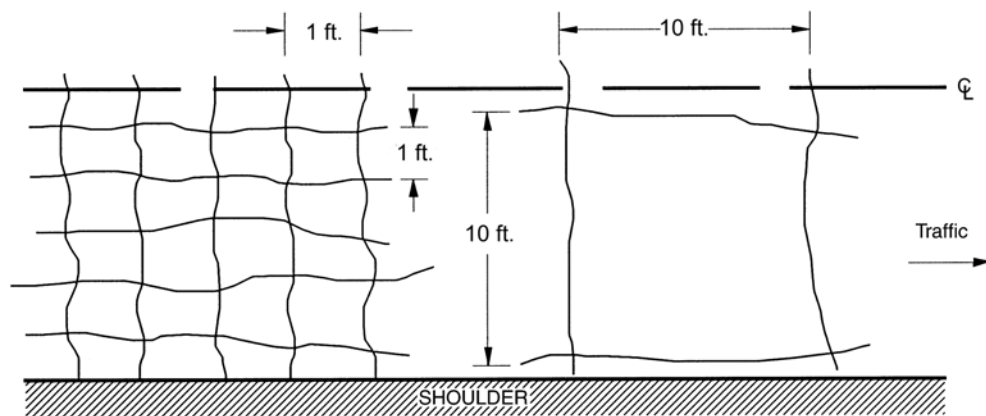

Figure 6 - Block Cracking



Figure 7 - Block Cracking

Block Cracking (Continued)

Severity Levels:

Low: Crack widths are less than 0.25 inch or sealed cracks of undetermined width have sealant in good condition.

Moderate: Crack widths that range from 0.25 inch to 0.75 inch or any crack width up to 0.75 inch and adjacent low severity random cracking.

High: Any crack with average width more than 0.75 inch or any crack width up to 0.75 inch and adjacent moderate to severe random cracking. (Figure 8)



Figure 8 - Block Cracking

Treatments:

Low Severity: This is a candidate for a crack filling treatment.

Moderate Severity: A recommended treatment can be a chip seal, Nova Chip, or HMA Overlay.

High Severity: The preferred treatment is a Surface Milling with a HMA Overlay.

Note: Surface cracks having heavy vegetation growth must be treated with herbicide 7 to 21 days prior to pavement work. A glyphosate herbicide, such as Roundup®, is recommended with 41% minimum active ingredient. After spraying vegetation, wait 5 – 7 days before cleaning the cracks. Debris should be thoroughly removed from the cracks, but never to a depth exceeding 4 inches.

3. Edge Cracking – [HMA Pavement Distress]

Description:

Edge cracking generally applies to pavements with unpaved shoulders. However, edge cracking can also occur adjacent to paved shoulder joints or curb and gutter sections, due to poor compaction or water infiltration. The cracks run parallel to and usually within 24 inches of the outer edge of the pavement. Edge cracking is accelerated by traffic loading and can be caused by a frost-weakened base or subgrade near the pavement edge. The area between the cracking and the pavement edge is termed “raveled” if it breaks up, sometimes with pieces removed. (Figure 9)

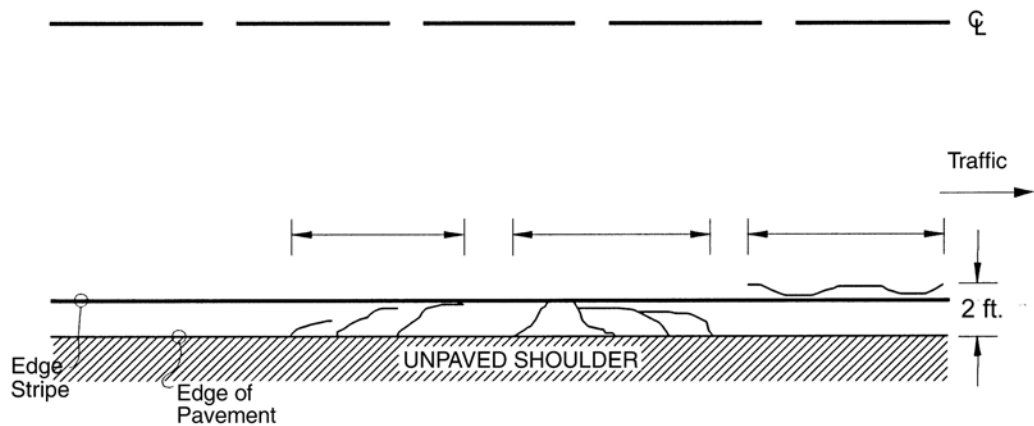

Figure 9 - Edge Cracking

Severity Levels:

Low: Low or medium cracking with no breakup or raveling. (Figure 10)

Moderate: Medium cracking with some breakup and raveling occurring up to 10 percent of the length of affected pavement.

High: Considerable break up or raveling of more than 10 percent the length of the affected pavement.

Edge Cracking (Continued)



Figure 10 - Edge Cracking

Treatments:

Low: No treatment necessary.

Moderate: Consider a crack filling treatment.

High: Saw cut full depth along the edge of pavement removing raveled and broken sections. Inspect the base material and stabilize or repair if necessary. Replace removed sections with full depth compacted HMA patching material. Consider adding a paved HMA shoulder (minimum depth of 3 inches) as part of the repair if traffic has been driving on the edge of the pavement.

Note: Surface cracks having heavy vegetation growth must be treated with herbicide 7 to 21 days prior to pavement work. A glyphosate herbicide, such as Roundup®, is recommended with 41% minimum active ingredient. After spraying vegetation, wait 5 – 7 days before cleaning the cracks. Debris should be thoroughly removed from the cracks, but never to a depth exceeding 4 inches.

4. Longitudinal Cracking – [HMA Pavement Distress]

Description:

Longitudinal cracks (Figure 11) run parallel to the centerline (may be either in the wheel paths or outside). These types of cracks are caused by poor construction of the paving lane joint, shrinkage of the pavement surface as a result of low temperatures, or asphalt hardening and /or daily temperature cycling.

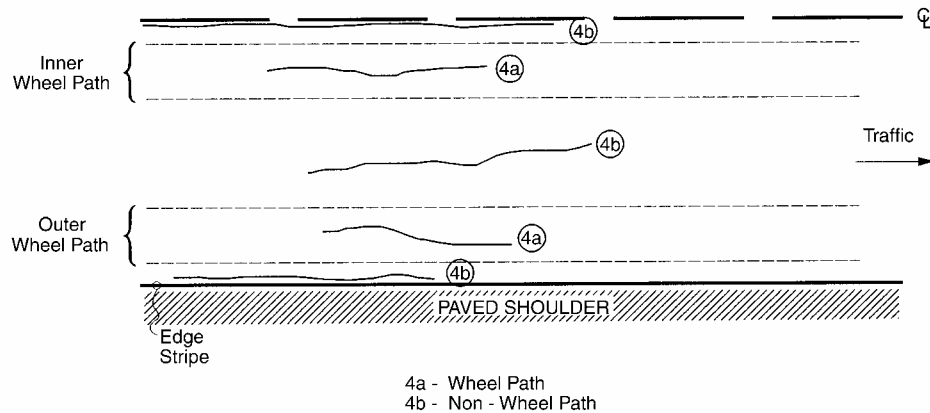

Figure 11 - Longitudinal Cracking

Severity Levels:

Low: Crack widths averaging less than 0.25 inch or filled cracks of any width in good condition.

Moderate: Cracks averaging between 0.25 inch and 0.75 inch or any crack width up to 0.75 inch plus adjacent low severity random cracking. (Figure 12)

Longitudinal Cracking (Continued)



Figure 12 - Moderate Severity Longitudinal Cracking in the Wheel Path

High: Cracks averaging over 0.75 inch or any crack with average width or less than 0.75 inch plus adjacent moderate to high severity random cracking. (Figure 13)



Figure 13 - High Severity Longitudinal Cracking not in Wheel Path

Longitudinal Cracking (Continued)

Treatments:

Low: This is a candidate for a crack fill treatment.

Moderate: Consider the crack fill treatment or crack fill followed by a chip seal, sand seal or Nova Chip.

High: The treatments that can be considered include HMA Overlay, or a surface milling with a HMA Overlay.

Note: Surface cracks having heavy vegetation growth must be treated with herbicide 7 to 21 days prior to pavement work. A glyphosate herbicide, such as Roundup®, is recommended with 41% minimum active ingredient. After spraying vegetation, wait 5 – 7 days before cleaning the cracks. Debris should be thoroughly removed from the cracks, but never to a depth exceeding 4 inches.

5. Reflective Cracking – [HMA Pavement Distress]

Description: This distress (Figure 14) occurs on asphalt surfaced pavements which have been laid over a Portland Cement Concrete (PCC) base or an old asphalt pavement and is not load-related. However, traffic loading may cause breakdown of the asphalt near the crack. When the pavement is fragmented along a crack, the crack is said to be “spalled”.

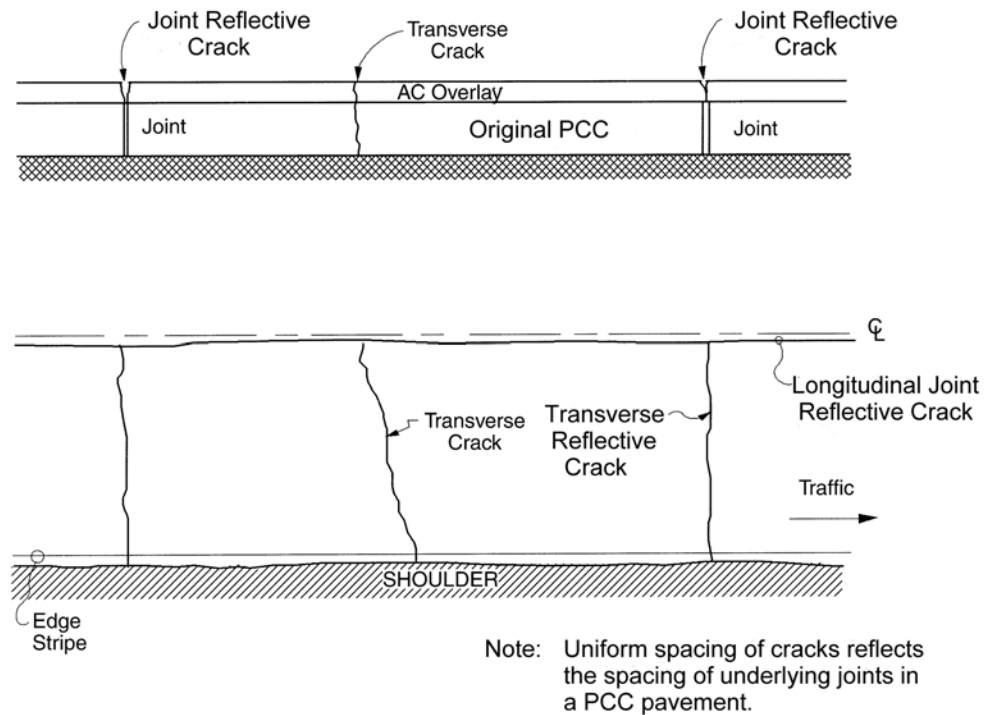

Figure 14 - Reflective Cracking

Severity Levels:

Low: Any unfilled crack width averaging less than 0.25 inch or any sealed crack with sealant material in good condition and a width that can not be determined.

Moderate: Any crack width averaging between 0.25 inch and 0.75 inch or any crack averaging less than 0.75 inch plus adjacent low severity random cracking.

High: Any crack width averaging more than 0.75 inch or any crack less than 0.75 inch plus adjacent moderate to high severity random cracking. (Figure 15)

Reflective Cracking (Continued)



Figure 15 - High Severity Reflection Cracking at Joints

Treatments:

Low: Apply a crack fill treatment.

Moderate: Apply a crack fill or a crack sealing treatment.

High: Mill and Fill treatment.

Note: Surface cracks having heavy vegetation growth must be treated with herbicide 7 to 21 days prior to pavement work. A glyphosate herbicide, such as Roundup®, is recommended with 41% minimum active ingredient. After spraying vegetation, wait 5 – 7 days before cleaning the cracks. Debris should be thoroughly removed from the cracks, but never to a depth exceeding 4 inches.

6. Transverse Cracking – [HMA Pavement Distress]

Description: Cracks which are predominately perpendicular to the pavement centerline (Figure 16).

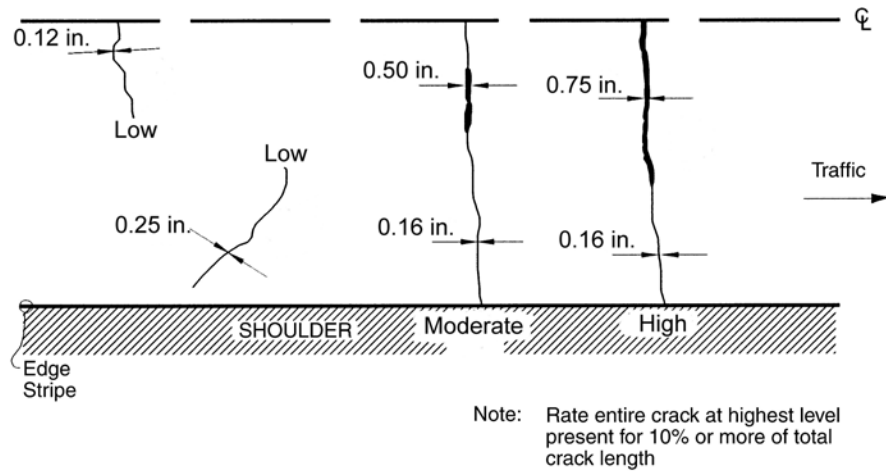

Figure 16 - Transverse Cracking

Severity Levels:

Low: Any unsealed crack with a mean width up to 0.25 inch or a crack with good condition sealant plus an undetermined width. (Figure 17)



Figure 17 - Low Severity Transverse Cracking

Transverse Cracking (Continued)

Moderate: Any crack width averaging between 0.25 inch and 0.75 inch or any crack up to 0.75 inch and adjacent low severity random cracking.
(Figure 18)



Figure 18 - Moderate Severity Transverse Cracking

High: Any crack width greater than 0.75 inch or any crack averaging less than 0.75 inch plus adjacent moderate to high severity random cracking.
(Figure 19)



Figure 19 - High Severity Transverse Cracking

Transverse Cracking (Continued)

Treatments:

Low: This is crack fill or crack seal candidate.

Moderate: Consider the crack fill, crack seal, sand seal, chip seal or Nova Chip treatments.

High: This should be candidate for HMA Overlay, or a surface milling with a HMA Overlay.

Note: Surface cracks having heavy vegetation growth must be treated with herbicide 7 to 21 days prior to pavement work. A glyphosate herbicide, such as Roundup®, is recommended with 41% minimum active ingredient. After spraying vegetation, wait 5 – 7 days before cleaning the cracks. Debris should be thoroughly removed from the cracks, but never to a depth exceeding 4 inches.

7. Rutting – [HMA Pavement Distress]

Description: Rutting (Figures 20 and 21) is a longitudinal surface depression in the wheel path that may not be noticeable until after rain (Figure 22) fills the ruts. Rutting is a lateral material deformation in any of the pavement layers or sub-grade caused by traffic loading. This type of distress can lead to a major structural failure.

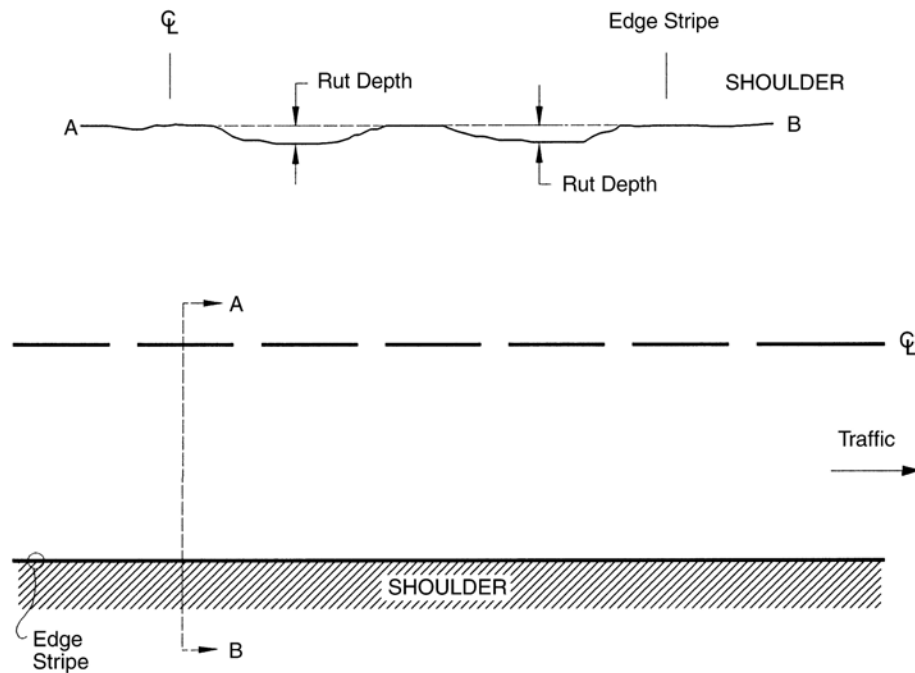

Figure 20 - Rutting



Figure 21 – Rutting

Rutting (Continued)



Figure 22 - Standing Water in Ruts

Severity Levels: Severity levels may be categorized by rut depth.

Low: Rutting depth ranges from 0.25 inch to 0.5 inch.

Moderate: Rutting depth ranges from 0.5 inch to 1 inch.

High: Rutting depth exceeds 1 inch.

Treatments:

Colorado DOT
Distress Identification Manual
October 2004

Low: No repair required or micro-surface if rutting is approaching 0.5 inch.

Moderate: Consider micro-surfacing or surface milling and a HMA Overlay.

High: The preferred treatment for a rut depth less than 1.5 inches is a surface milling and a HMA Overlay.

8. Shoving – [HMA Pavement Distress]

Description: Shoving is a longitudinal displacement of a localized area of pavement surface, sometimes associated with vertical displacement. This distress is generally caused by braking or accelerating vehicles and is usually located on hills, curves or at intersections. (Figures 23 and 24)

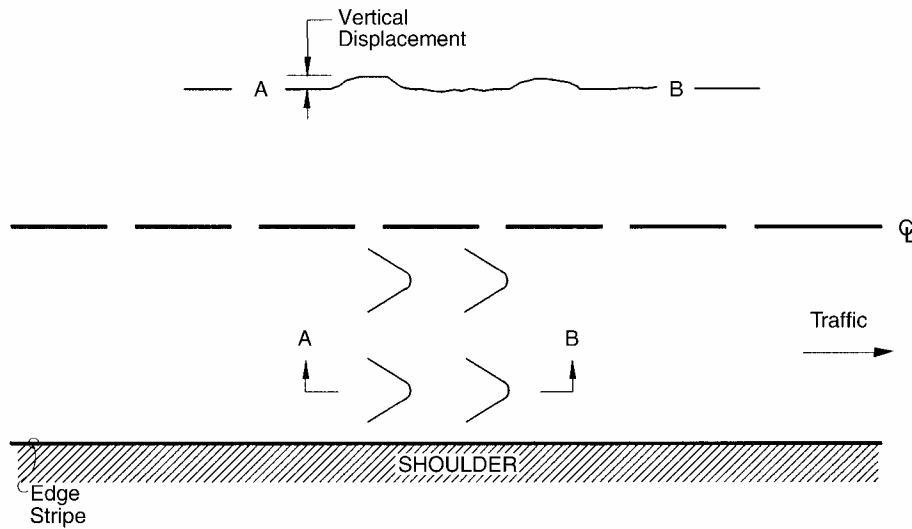

Figure 23 - Shoving



Figure 24 - Shoving in Pavement surface

Severity Levels: The three severity levels may be defined by the relative effect of shoving on ride quality values.

Shoving (Continued)

Treatments:

Low: Nothing is required.

Moderate: Surface milling and a HMA Overlay is the preferred treatment.

High: Surface milling and a HMA Overlay is the preferred treatment.

9. Bleeding – [HMA Pavement Distress]

Description: Bleeding, which usually occurs in wheel paths, is excess bituminous binder material which has leaked to the surface, making a glass-like, tacky, reflective surface hiding the aggregate particles. This distress condition is caused by excess asphalt cement in the mix, excess sealant and / or low air void content during hot weather. As this process is not reversible in cold weather, tar will continue to accumulate on the surface over time. (Figures 25, 26, and 27)

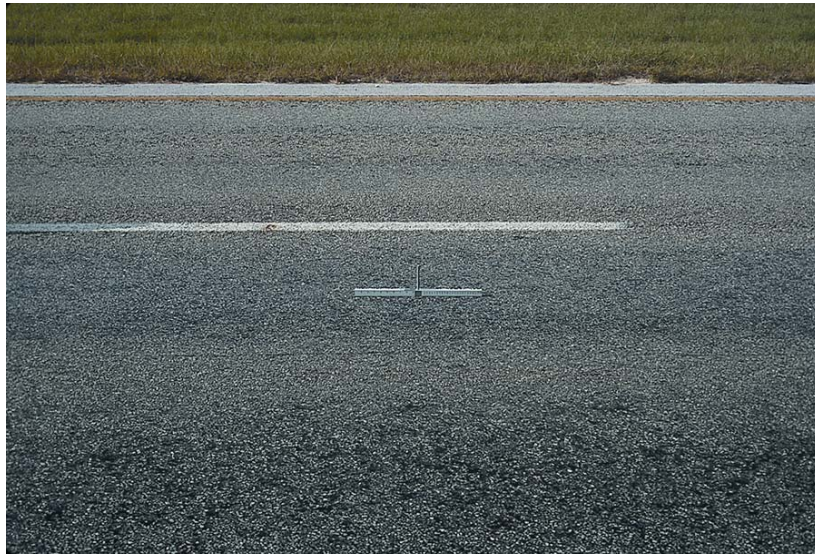

Figure 25 – Discoloration



Figure 26 - Loss of Texture

Bleeding (Continued)



Figure 27 - Aggregate Obscured

Severity Levels: The presence of bleeding indicates a potential mixture formulation problem and its extent should be monitored.

Low: Bleeding is noticeable only a few days of the year and does not stick to shoes or tires.

Moderate: Asphalt sticks to shoes and /or tires during a few days of the year.

High: Bleeding occurs extensively and sticks to shoes and tires during several days of the year.

Treatments:

Low: Although no repairs are required, the condition should be monitored for future correction.

Moderate: Consider a chip seal or sand seal.

High: The treatments that can be considered include a HMA Overlay or a surface milling with a HMA Overlay.

10. Polished Aggregate – [HMA Pavement Distress]

Description: Traffic has worn the surface binder away to expose the coarse aggregate particles. Once the aggregate particles become worn smooth, the surface friction may be reduced to unsafe levels.

Severity Levels: Although severity levels have not been identified, the degree of polishing should be significant on at least 70% of the exposed aggregate. (Figure 28)



Figure 28 - Polished Aggregate

Treatments: Roadways and intersections requiring a reasonable coefficient of friction should be given a chip seal, sand seal, or micro-surfacing treatment to increase vehicular tire adhesion when braking or stopping.

11. Raveling – [HMA Pavement Distress]

Description: Raveling is the wearing away of the pavement surface caused by dislodging of aggregate particles and the loss of asphalt binder. This distress ranges from loss of fine aggregate (Figure 29) to loss of fine and some coarse aggregate (Figure 30) and ultimately to a very rough and pitted surface (Figure 31). This can be caused by hardened binder, a poor quality mix or softened surface due to oil spillage.



Figure29 - Loss of Fine Aggregate

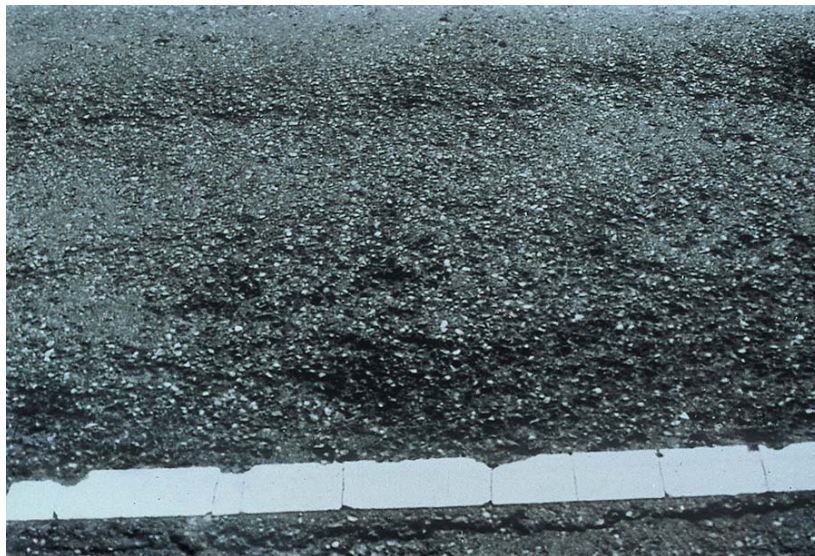

Figure 30 - Loss of Fine and Some Course Aggregate

Polished Aggregate (Continued)



Figure 31 - Loss of Course Aggregate

Severity Levels: Raveling indicates potential mix problems and should be monitored.

Low: Aggregate or binder has started to wear away with some pitting. If oil spillage has occurred, the stain is visible but the pavement surface may not be deformed.

Moderate: Aggregate and / or binder has worn away with a moderately rough and pitted surface. If there oil spillage has occurred, the surface is soft and can be deformed.

High: Aggregate and / or binder has considerable wear and is very rough and severely pitted. Pitted areas larger than 4 inches in diameter and more than 0.5 inch deep are considered potholes.

Treatments:

Low: This is a good candidate for a chip seal or sand seal treatment.

Moderate: Apply a micro-surfacing treatment.

High (Small Areas): Consider applying a surface milling and fill with a HMA mixture.

High (Large Areas): Remove loose material and clean existing surface, apply tack coat, and overlay with 1.5 inch of HMA asphalt overlay or a Nova Chip.

II Distresses in Portland Cement Concrete (PCC) Pavements

1. Corner Breaks – [Rigid Pavement Distress]

Description: A Corner Break is a slab fracture along a line intersecting the adjacent transverse and longitudinal joints at approximately 45 degrees. The lengths of the fractured sides range from 12 inches to one half the slab width. (Figure 32)

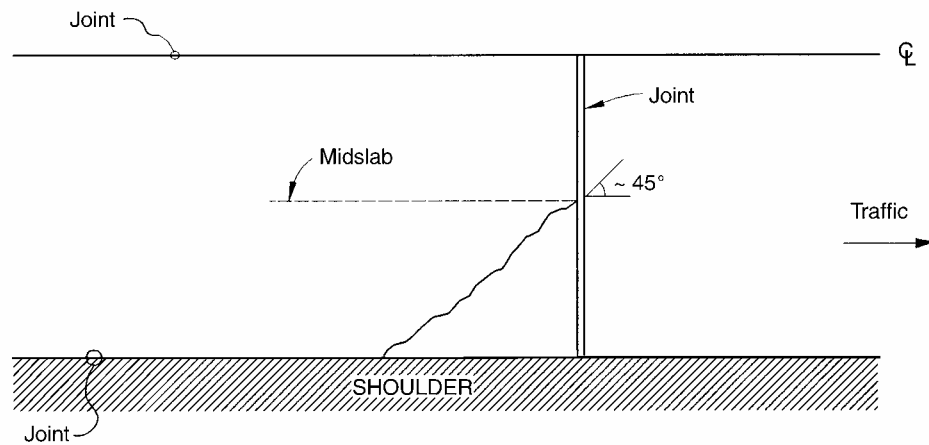

Figure 32 - Corner Breaks

Severity Levels:

Low: The crack is not spalled for more than 10% of the crack length, there is no faulting, the corner piece is not broken into two or more parts and there is no loss of material or patching. (Figure 33)

Corner Breaks (Continued)



Figure 33 - Low Severity Corner Break

Moderate: Crack shows low-severity spalling for more than 10% of its total length or faulting of the crack or joint is less than 0.5 inch or the corner piece has not broken into two or more parts. (Figure 34)



Figure 34 - Moderate Severity Corner Break

High: Crack shows moderate to high severity spalling over 10% of its total length or faulting of the crack or joint is at least 0.5 inch or the corner piece has broken into two or more parts or patching material is present.

Corner Breaks (Continued)

Treatments:

Low & Medium: These are good candidates for the concrete crack sealing treatment. After cleaning out the crack, seal any crack over 0.125 inch wide with crack sealant.

High: The preferred treatment is the Full Depth Concrete Pavement Repair treatment. Saw cut the slab full depth into a rectangular section and remove old pavement. After inspection of base material, stabilize or repair as required. Pour new concrete section with dowelled expansion joint and construction joint and cure according to local conditions.

2. Durability Cracking (“D” Cracking) – [Rigid Pavement Distress]

Description: “D” Cracking is a distress caused by freeze/thaw expansion of the coarse aggregate which breaks down the concrete slab over time. Dark color staining due to saturation near joints and closely spaced fine crescent shaped cracks may lead to eventual disintegration of the entire slab. (Figure 35)

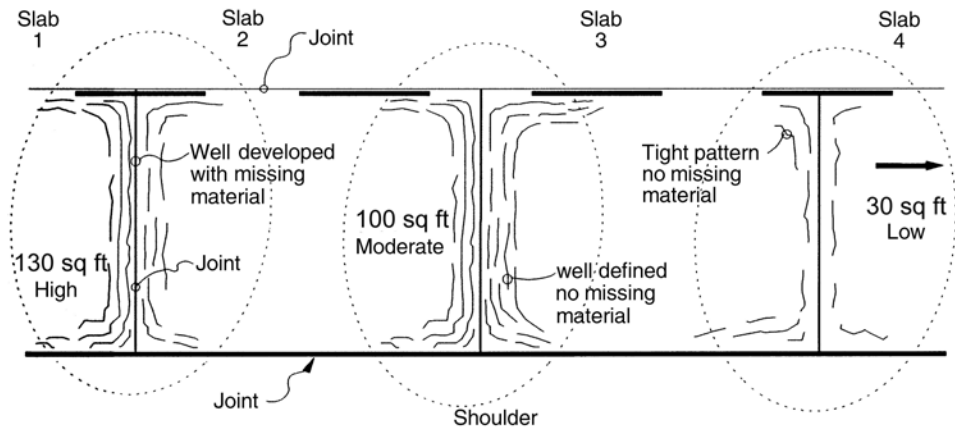

Figure 35 - Durability Cracking

Severity Levels:

Low: The “D” cracks are tight with no missing or loose pieces or patching from previous repairs.

Moderate: The “D” cracks are well-defined and some pieces are loose or missing. (Figure 36)

Durability Cracking (Continued)

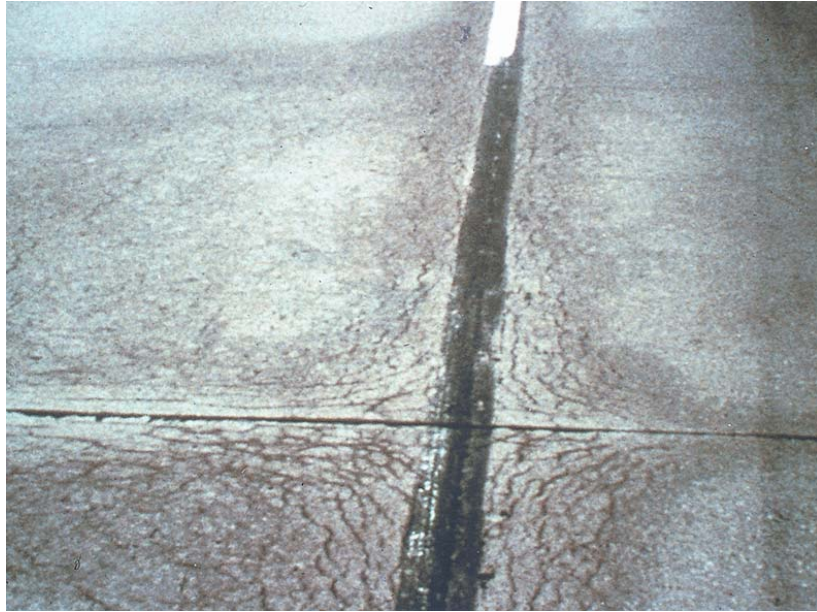

Figure 36 - Moderate Severity “D” Cracking with Well Defined Pattern

High: The “D” cracking has progressed to a well-developed pattern with a significant amount of loose material. Displaced pieces up to 1 square foot in size may have been patched. (Figure 37)



Figure 37 - High Severity “D” Cracking with Loose and Missing Material

Durability Cracking (Continued)

Treatments:

Low & Moderate: Monitor for future repair.

High: This may be a candidate for the Full Depth Concrete Pavement Repair treatment.

Note: The extent of major “D” cracking may determine that major rehabilitation or reconstruction is required.

3. Longitudinal Cracking – [Rigid Pavement Distress]

Description: Cracks that are predominantly parallel to the pavement centerline caused by a combination of repeated traffic loading, thermal gradient curling, and repeated moisture loading. (Figure 38)

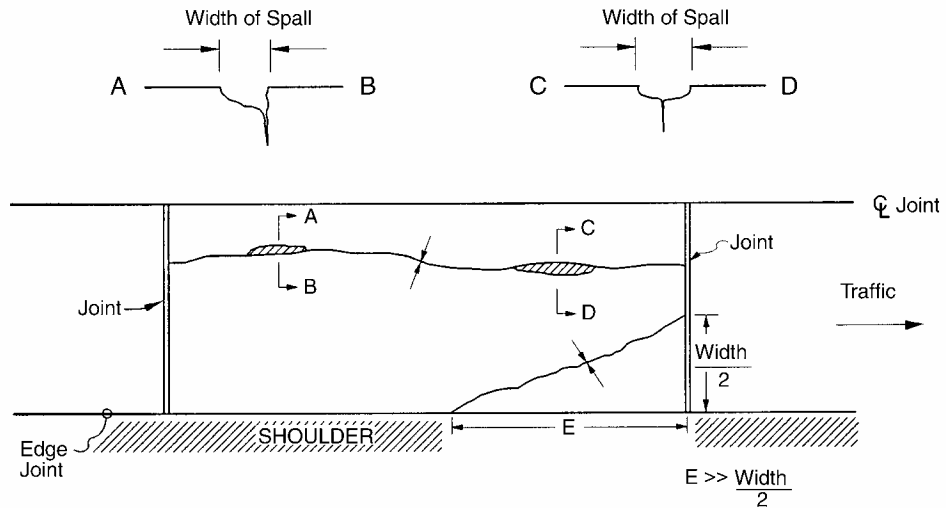

Figure 38 - Longitudinal Cracking

Severity Levels:

Low: Crack widths less than 0.1 inch, no spalling and no measurable faulting; or well sealed cracks having widths that cannot be measured (Figure 39).



Figure 39 - Low Severity Longitudinal Cracking

Colorado DOT
Distress Identification Manual
October 2004

Longitudinal Cracking (Continued)

Moderate: Crack widths at least 0.1 inch up to 0.5 inch; or with spalling less than 3 inches; or faulting up to 0.5 inch (Figure 40).



Figure 40 - Moderate Severity Longitudinal Cracking

High: Crack widths at least 0.5 inch; or with spalling at least 3 inches; or faulting at least 0.5 inch (Figure 41).



Figure 41 - High Severity Longitudinal Cracking

Longitudinal Cracking (Continued)

Treatments:

Low: This is a candidate for the concrete crack sealing treatment.

Moderate & High: The recommended treatments for this severity level are Concrete crack sealing with partial depth repair and diamond grinding to remove the faulting in the high severity areas.

4. Transverse Cracking – [Rigid Pavement Distress]

Description: Cracks that are predominantly perpendicular to the pavement centerline caused by a combination of repeated traffic loading, thermal gradient curling, and repeated moisture loading. (Figure 42)

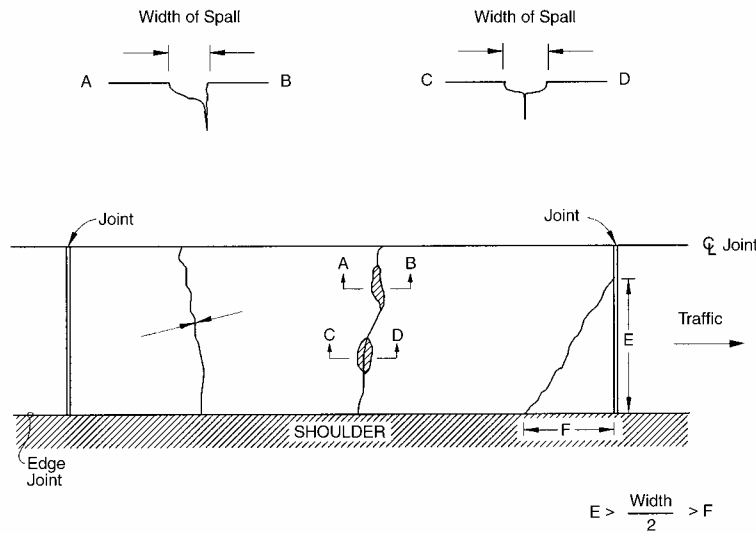

Figure 42 - Transverse Cracking

Severity Levels:

Low: Crack widths less than 0.1 inch, no spalling, and no measurable faulting; or well sealed cracks having widths that cannot be measured.

Moderate: Crack widths at least 0.1 inch up to 0.2 inch; or with spalling less than 3 inch; or faulting up to 0.2 inch (Figure 43).

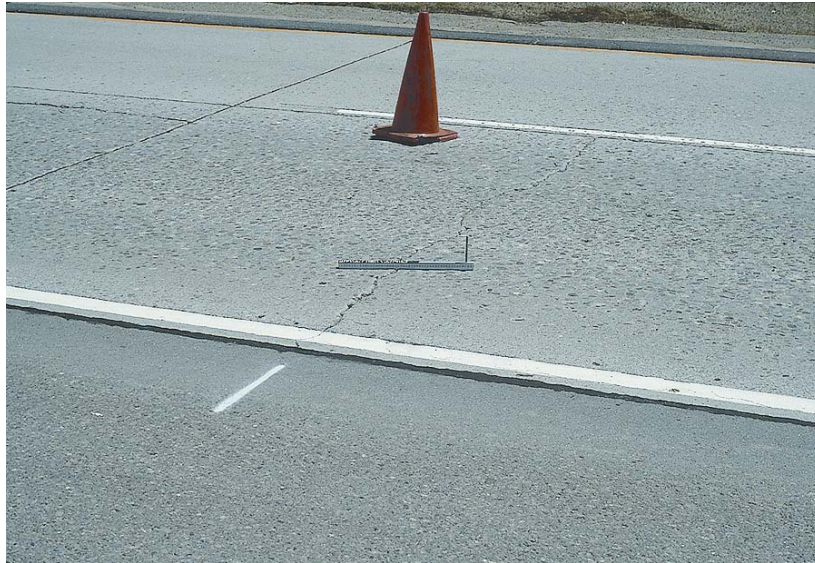

Figure 43 - Moderate Severity Transverse Cracking

Transverse Cracking (Continued)

High: Crack widths at least 0.2 inch; or with spalling at least 3 inch; or faulting at least 0.2 inch (Figure 44).



Figure 44 - High Severity Transverse Cracking

Treatments:

Low: This is a candidate for Concrete Crack Sealing.

Moderate: The Concrete Crack Sealing treatment with the Partial Depth Repair treatment to repair the spall areas.

High: In addition to the treatments for the moderate severity level, the Diamond Grinding treatment should be used to fix the faulting.

* Spalling may be addressed by partial depth repair - requires reforming and sealing cracks.

Note: Surface cracks having heavy vegetation growth must be treated with herbicide 7 to 21 days prior to pavement work. A glyphosate herbicide, such as Roundup®, is recommended with 41% minimum active ingredient. After spraying vegetation, wait 5 – 7 days before cleaning the cracks. Debris should be thoroughly removed from the cracks, but never to a depth exceeding 4 inches.

5. Joint Seal Damage (Longitudinal and Transverse) – [Rigid Pavement Distress]

Description: Joint seal damage is any condition which enables incompressible materials or water to infiltrate the joint from the surface.

Severity Levels: Severity levels do not apply to longitudinal joint seals. Severity levels for transverse joint seals are as follows:

Low: Joint seal damage extends over 10% of the joint. (Figure 45)



Figure 45 - Low Severity Joint Seal Damage

Moderate: Joint seal damage extends over 10% - 50% of the joint.

High: Joint seal damage extends over 50% of the joint.

Treatments:

Low: Monitor for future repair.

Moderate & High: Concrete Joint Resealing.

Note: Surface cracks having heavy vegetation growth must be treated with herbicide 7 to 21 days prior to pavement work. A glyphosate herbicide, such as Roundup®, is recommended with 41% minimum active ingredient. After spraying vegetation, wait 5 – 7 days before cleaning the cracks. Debris should be thoroughly removed from the cracks, but never to a depth exceeding 4 inches.

6. Longitudinal Joint Spalling – [Rigid Pavement Distress]

Description: Cracking, breaking, or chipping of concrete slab edges within 12 inches of the face of the longitudinal joint. (Figure 46)

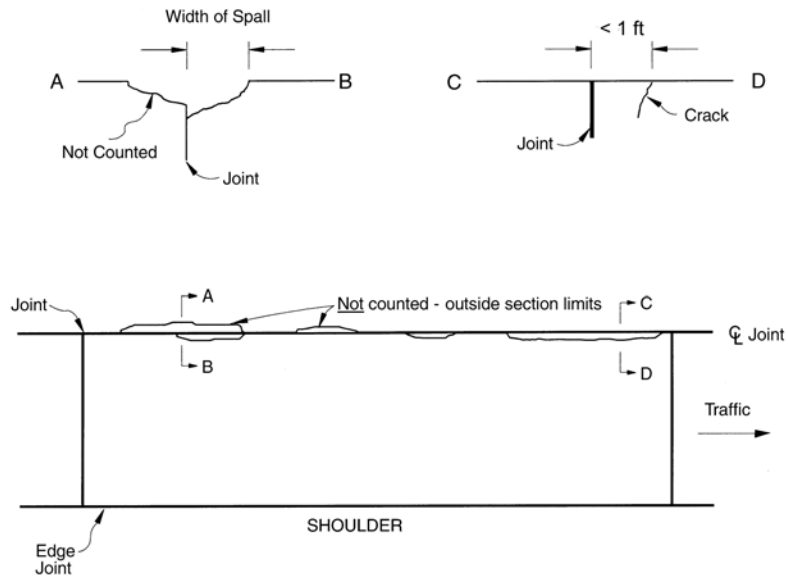

Figure 46 - Spalling of Longitudinal Joints

Severity Levels:

Low: Spalls up to 3 inches wide, measured to the face of the joint, with loss of material, or spalls with no loss of material and no patching (Figure 47).



Figure 47 - Low Severity Spalling of Longitudinal Joint

Longitudinal Joint Spalling (Continued)

Moderate: Spalls 3 inches to 6 inches wide, measured to the face of the joint, with loss of material.

High: Spalls greater than 6 inches wide, measured to the face of the joint, with loss of material or broken into two or more pieces or containing patching material from a previous repair (Figure 48).



Figure 48 - High Severity Spalling of Longitudinal Joint

Treatments:

Low: This is a candidate for the Concrete Joint Resealing treatment.

Moderate & High: The Concrete Joint Resealing and Partial Depth Repair treatments are the recommended treatments..

7. Transverse Joint Spalling – [Rigid Pavement Distress]

Description: Cracking, breaking, or chipping of concrete slab edges within 12 inches of the face of the transverse joint. (Figure 49)

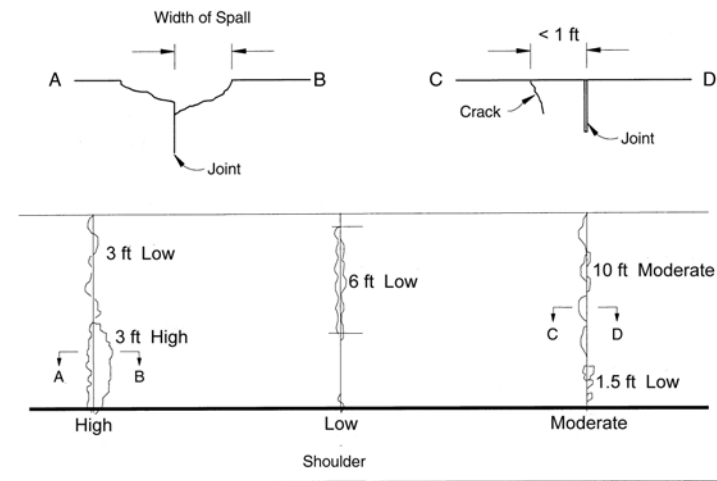

Figure 49 - Spalling of Transverse Joints

Severity Levels:

Low: Spalls up to 3 inches wide, measured to the face of the joint, with loss of material, or spalls with no loss of material and no patching.

Moderate: Spalls 3 inches to 6 inches wide, measured to the face of the joint, with loss of material. (Figures 50 and 51)



Figure 50 - Moderate Severity Spalling of Transverse Joint, Far View

Transverse Joint Spalling (Continued)



Figure 51 - Moderate Severity Spalling of Transverse Joint, Close-up View

High: Spalls greater than 6 inches wide, measured to the face of the joint, with loss of material or broken into two or more pieces or containing patching material from a previous repair.

Treatments:

Low & Moderate: The recommended treatments are the Concrete Joint Resealing and Partial Depth Repair.

High: The Concrete Joint Resealing and Partial Depth Repair treatments are recommended for the less severe spalls. If the transverse width of spalled area approaches 2 ft., consider Full Depth Concrete Pavement Repair.

8. Map Cracking and Scaling – [Rigid Pavement Distress]

Description: Map Cracking (Figure 52) is a series of hairline cracks that extend only into the upper surface of the slab. These cracks, which tend to intersect at angles of 120 degrees, are caused by over-finishing of the concrete and may lead to scaling to a depth of 0.125 inch to 0.5 inch. Scaling (Figures 53 and 54) is also caused by deicing salts, improper construction, freeze/thaw cycles and poor quality coarse aggregate.



Figure 52 - Map Cracking



Figure 53 – Scaling

Map Cracking and Scaling (Continued)

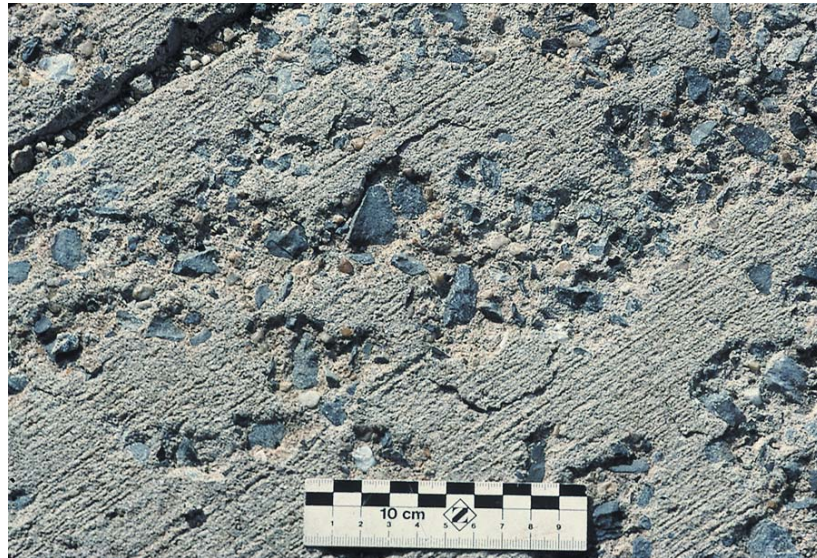

Figure 54 - Scaling, Close-up View

Severity Levels:

Low: Map cracking exists over most of the slab area and the surface is in good condition with only minor scaling present.

Moderate: The slab shows less than 15% scaling of the surface.

High: More than 15% of the surface is scaled.

Treatments:

Low: Do nothing except monitor for future deterioration.

Moderate: Partial depth repair treatment in isolated areas is recommended.

High: This severity level is probably beyond pavement preservation options and should be handled as a rehabilitation or reconstruction project.

9. Polished Aggregate – [Rigid Pavement Distress]

Description: Surface mortar and texturing has worn away to expose the coarse aggregate particles. (Figure 55)



Figure 55 - Polished Aggregate

Severity Levels: The degree of polishing may be reflected in a reduction of surface friction resulting in less safe driving conditions.

Treatments: Diamond grind the pavement surface to increase friction and tire traction.